

OPÔLIA

Add: #366, Guanghua 3rd Road, Baiyun District, Guangzhou, China
www.oppoliahome.com

+86-20-36730513
sales@oppolia.com
Oppolia Home



OPPOLIA Website



OPPOLIA Wechat



360° Showroom



2021 KITCHENS

OPPOLIA, My Home, My Style

OPÔLIA

www.oppoliahome.com



CONTENTS

- 01 2021 New Arrival
- 25 Modern
- 43 Minimalism
- 49 Industrial
- 51 Entry Luxury
- 71 Nordic
- 77 European Minimalism
- 81 American
- 83 Classic



118

Export countries

7,000+

Global showrooms

10,000+

Projects worldwide

ABOUT OPPOLIA

OPPOLIA is a sub brand of OPPEIN, establish for retail customer, factory direct sale mode and whole house production solution for customer's convenience.

Founded in 1994, OPPEIN is China's No.1 kitchen and customized home décor brand, and Asia's largest cabinetry manufacturer. We design and manufacture high-quality kitchens, wardrobes, bespoke home furniture, bathroom products, interior doors, aluminum windows & doors and home furnishing, capable of offering one-stop home décor products and solutions. Output and sales of kitchen cabinet reached 830 thousand sets, ranking No.1 in the kitchen industry.

In 2020, OPPEIN's sales turnover reached USD 2.27 billion, havrvesting its consecutive 27th yrs of growth. our products have been exported to 118 countries and regions. And the total market value of OPPEIN exceeded 100 billion yuan (USD 15.3 billion) in March 2021.

In overseas markets, what sets us apart from our competitors is our Italy design, European quality, one-stop whole-house products & solutions, and reliable local services.

OPPEIN takes great pride in its extensive franchise distribution system. We have a productive showroom operation model and thoughtful support policies to help the franchisees win. Currently, we have a remarkable number of over 7,000 franchise showrooms worldwide to serve local retail businesses.

The global project business is another importance we attach to. We cooperate closely with builders, developers, contractors, and architects to develop different types of residential and commercial business; up to now, we have completed over 10,000 real estate projects around the globe, including some significant local landmark projects.

We achieve this through our unceasing striving for perfection, and the passion to satisfy an individual's needs for better home décor. Our vision is to make OPPEIN a modern, innovative company respected and loved by the people, held in the highest esteem in China, and emulated around the world.

Where there is home and love, there OPPEIN is.

1994

Establishment

China's first modern factory to custom make kitchen

1999

Brand Influence

Ranking No.1 both in kitchen sales turnover and brand influence in China

2003

Kitchen Standards

-The first to be selected as "the Drafting Unit of China's Residential Kitchen Standards"
-Setting up its USA office in Boston and starting to explore overseas markets

2009

Guangzhou HQ

-The first to be honored with "China Well-Known Trademark" in the industry
-1,100+ global showrooms
-Covering a total area of 444,000 SQM, OPPEIN Guangzhou HQ is put into use.

2011

The Largest Cabinetry Manufacturer in Asia

-Tianjin factory with a total area of 335,100 square meters in put into operation
-Becoming Asia's largest cabinetry manufacturer based on both factory size and production capacity

2007

China Top Brand

-The first to be honored with "China Top Brand" in the industry
-118 exporting countries

2017

Went Public

-Going public in Shanghai Stock Exchange
-Qingyuan factory with a total area of 989,300 square meters is put into operation

2020

Output No.1

Output and sales of kitchen cabinet reached 830 thousand sets, ranking No.1 in the kitchen industry.

Whole house Customization

-China's first to initiate and offer whole- house customization solution
-Setting up offices in India, Philippines, Australia, Kenya and Milan

2014

2015

Wuxi Center

Located in East China, OPPEIN Wuxi manufacturing center, with a total area of 519,400 SQM, is put into use.

2018

6800 Showrooms

-OPPEIN has 6,800+ showrooms worldwide
-OPPEIN has fulfilled 10,000+ real estate projects worldwide ever since 1994

2021

Market Value Breakthrough

-The total market value of OPPEIN exceeded USD 15.3 billion in March 2021.
-Reddot award 2021 winner

COMPANY MILESTONES

China's No.1 Kitchen & Customized Home Decor Brand
The Largest Cabinetry Manufacturer in Asia



AN IMMENSE FOREST PLCC21182

Style: Modern

Melamine PWMA0212, BWMA0025

Quartz Stone PWTY1078

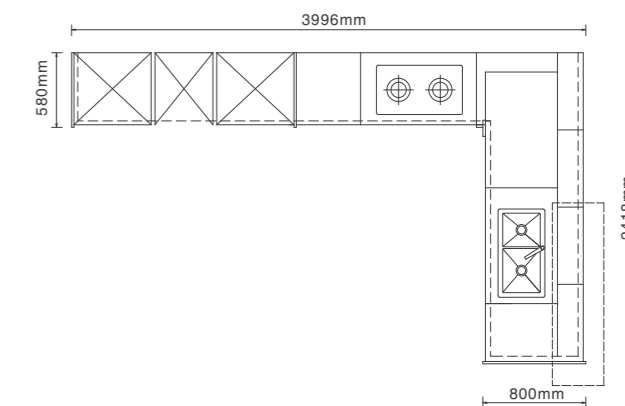



BLUES PLCC21146

Style: Industrial

Melamine PWMA0216, PWMA0217
Quartz Stone PWTY1081

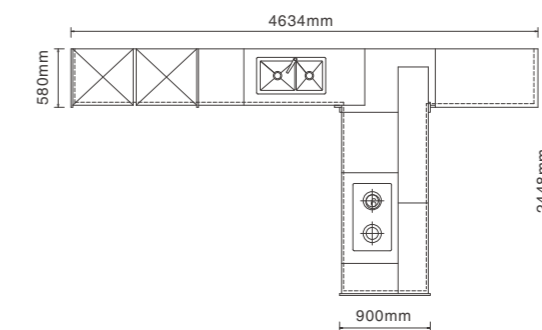

ZEPPELIN PLCC21113

Style: Industrial

HPL PWMF0064, PWMF0065
Sintered Surface PWTE0034

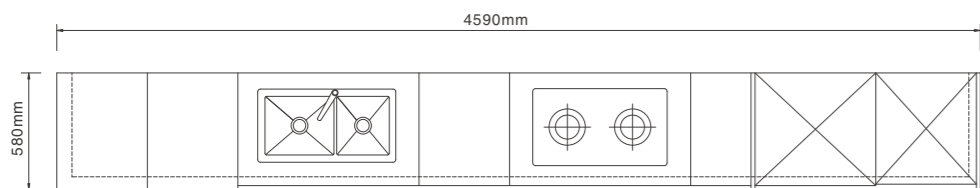



FANTASY PLCC21325

Style: Minimalism

Lacquer PWMK3022, BMWK2011
Sintered Surface PWTE007

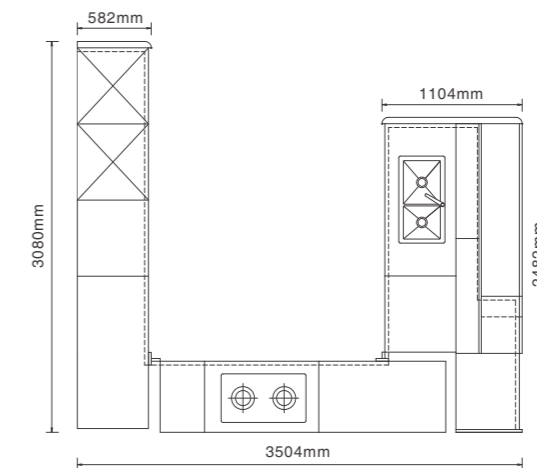



BEHRENS PLCC21051

Style: Minimalism
Lacquer PWMK5005, PWMK5004
Sintered Surface PWTE0034

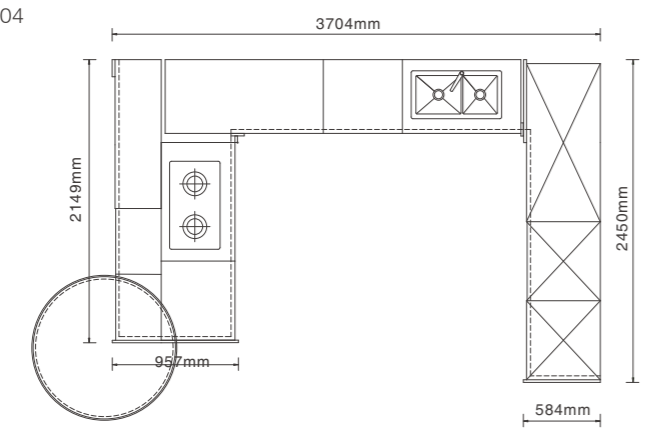



HAYDN PLCC21326

Style: Minimalism

Lacquer PWMK7008, BWMK2011

Sintered Surface PWTE0030

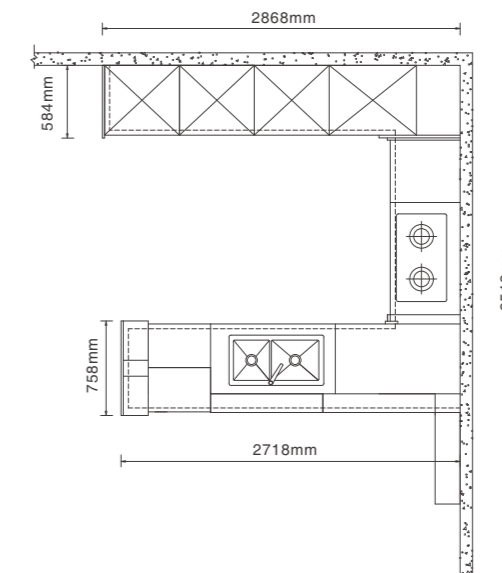

SECRET GARDEN PLCC21043

Style: Entry Luxury

Lacquer PWMK5001, PWMK2112
Sintered Surface PWTE0008

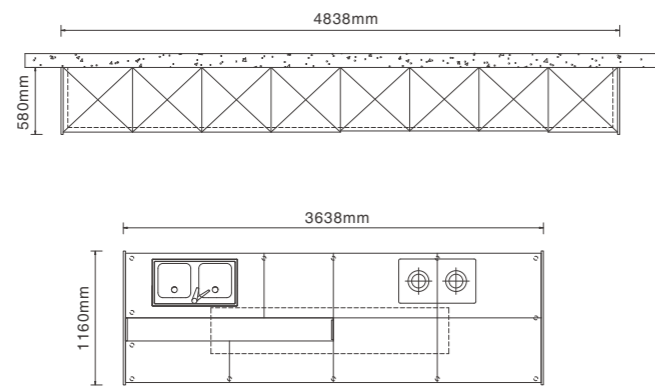



GREEN FOREST PLCC21347

Style: Entry Luxury

UV Lacquer PWMC0064, PWMC0029

Quartz Stone PWTY1008

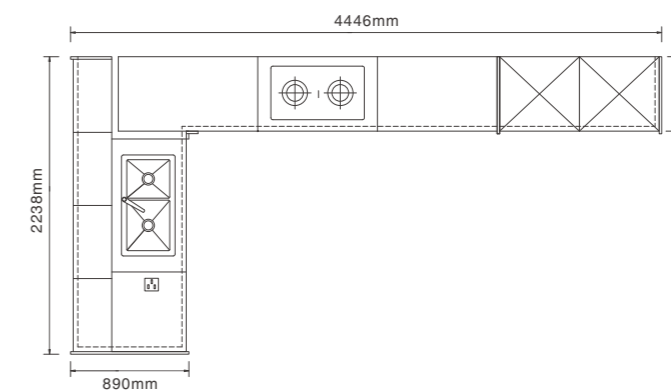

SERENADE PLCC21339

Style: Entry Luxury

UV Lacquer PWMC0060+Melamine PWMA0119
Sintered Surface PWTE0034

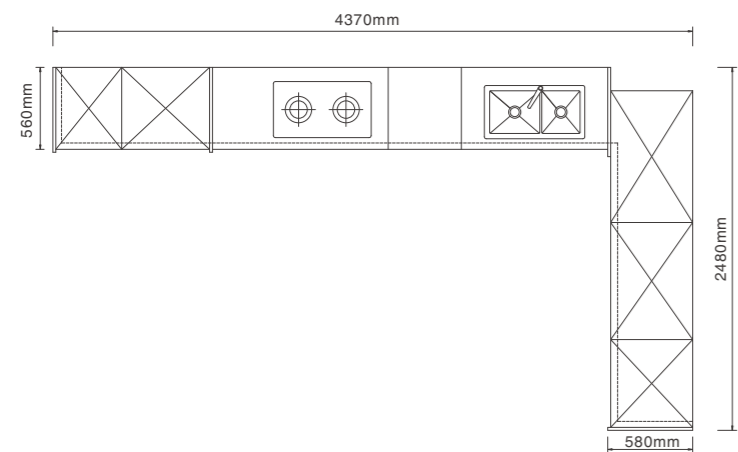



BRESSANONE PLCC21340

Style: Entry Luxury

UV Lacquer PWMC0063, PWMC0080
Sintered Surface PWTE0030

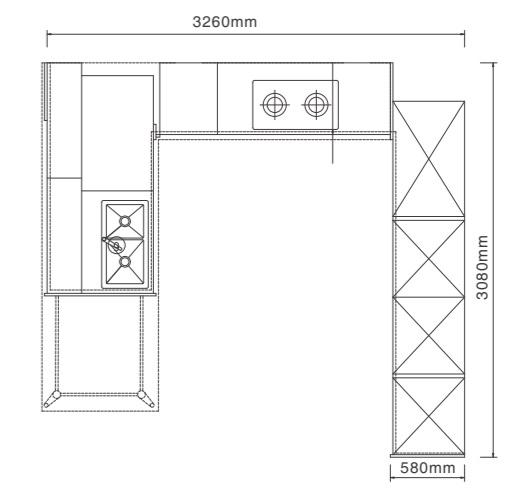

SWAN LAKE PLCC21128

Style: Entry Luxury

UV Lacquer PWMC0061, BWMK2011

Quartz Stone PWTY1031

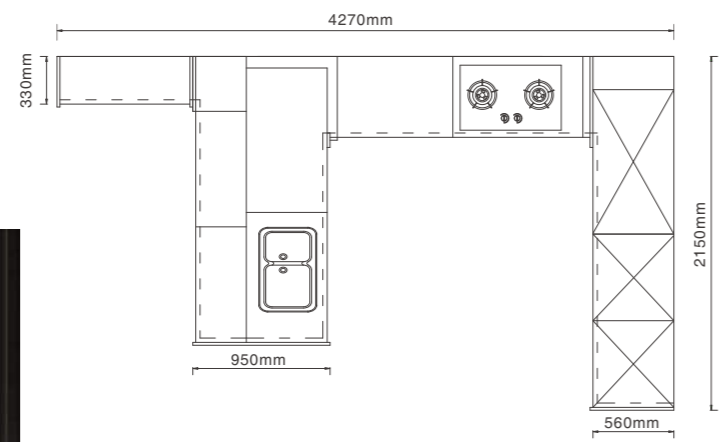



YUN FU PLCC21400

Style: Chinese

Melamine PWMA0218, PWMA0119

Sintered Surface PWTE0035

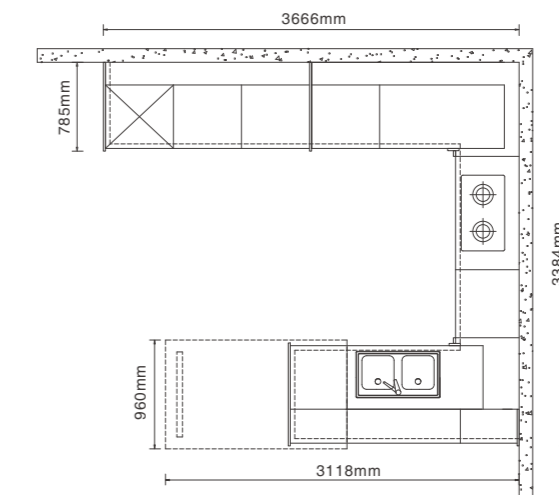

CAPHNE PLCC20059

Style: Modern

PVC PWMG0025

Oppein Quartz Stone P4 Series PWTY1032

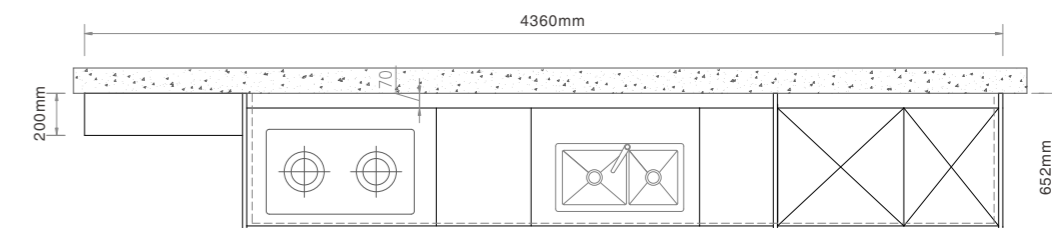

Low saturation Morandi pink contrasts finely with ink blue texture, demonstrating its soft and gentle appeal. Its matte coating in Morandi pink shows an attitude towards exquisiteness. The dark texture in a rock-like finish appears extraordinary and premium.



BASIL PLCC17027

Style: Modern

Lacquer PWMK5001, Melamine PWMA0015
Oppein Quartz Stone P4 Series PWTY1016

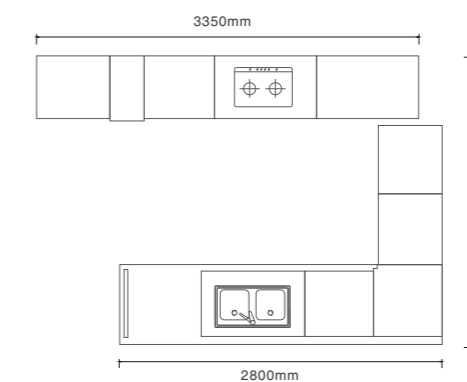

The shutter door on the left creates a beautiful and sleek yet practical kitchen; it reveals the space and conceals the clutter as you wish. Under the shutter door, the sliding multi-outlet socket offers power to your small electrical appliances on the worktop conveniently.

LYON PLCC18087

Style: Modern

Lacquer PWMK5002+Melamine PWMA0119
Oppein Quartz Stone P5 Series PWTY1033

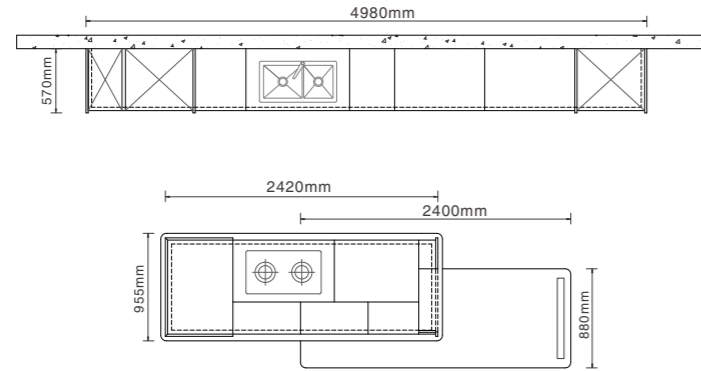

Classic silver car lacquer on door panels presents entry luxury style, featuring its endurance and shining texture. Additional lighting elements and brown glass door design lit up the gloomy and drowsy inner space, driving away all the negatives, bringing about a scene of prosperity and dynamic. Semi-symmetrical high cabinet design and classic parallel one-line kitchen layout create a simple but stylish appearance.





MONT BLANC PLCC18021

Style: Modern

Melamine PWMA0060, PWMA0103
Oppein Quartz Stone P4 Series PWTY1032

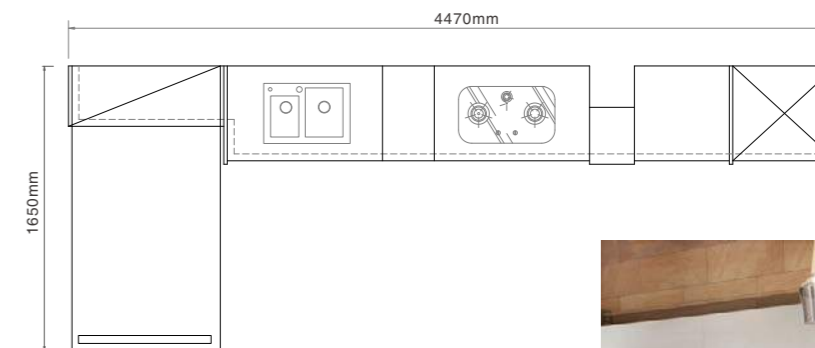

It comes out with its simple layout and a soft shade of color, modern and stylish. This picturesque design has formed a new kitchen concept of exquisiteness, elegance and coziness.



MOULIN ROUGE PLCC19112

Style: Modern

PVC PWMG0134+Melamine PWMA0115
Oppein Quartz Stone P5 Series PWTY1046

As Morandi colors encounter with dark brown oak, it just resembles an affectionate couple having their moments in an utterly romantic space, portraying a life of enthusiasm and passion. Its proportions is in a reasonable ratio; its layout is properly arranged; its ideal functional combinations and sufficient storage space are well set up, allowing an easier access for users' operations. A good kitchen like Moulin Rouge will also upgrade its new functions and features due to the use of the owner.

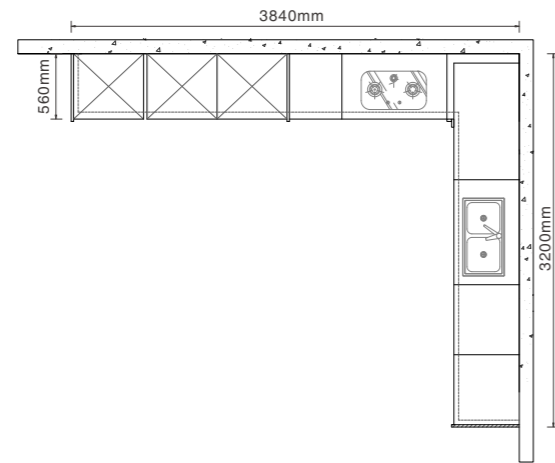



NOVA OP17-011

Style: Modern

HPL PWMF0016, PWMF0014

Oppein Quartz Stone P2 Series PWTY1008

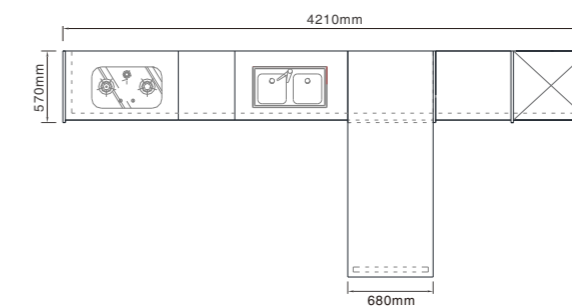

Despite its small size, NOVA is versatile for a fast-paced life. The extended worktop can be used either as an additional counter or as a dining table. It provides wine rack to store your wine; shortly it becomes a place to enjoy your leisure time.



LUV PLCC19144

Style: Modern

Melamine PWMA0127+Lacquer PWMK2006
Oppein Quartz Stone P5 Series PWTY1046

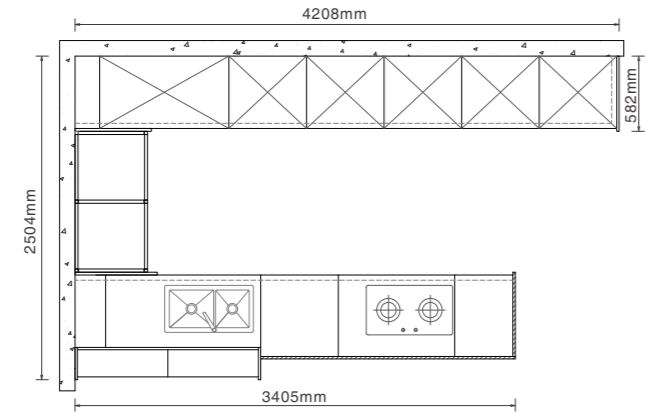

These hard straight edges come into a locally symmetrical structure, outlining modern simplicity and minimalism. Glass cabinets have added extra detail into it. Embellished with exquisite metal frame, it shows a modern and simple life style. The use of the warm lighting just blend the colors well, bringing about the resurgence of classics and luxury.





BRITAIN PLCC19065

Style: Modern

Melamine PWMA0112+Lacquer PWMK2074
Oppin Quartz Stone P5 Series PWTY1031

As gray is coming into fashion by the moment, Britain Style has kept up with the latest trends. Having gray-toned wood grain and transparent glass doors integrated in the design, it makes a perfect illustration of what a luxe life should be like. Everyone deserves to have a place of his own, to live out his life in an elegant manner, and to escape from the hustle and bustle of the city.

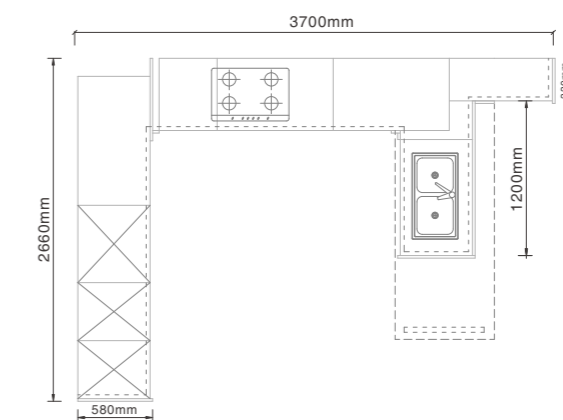

BROWNING PLCC18085

Style: Modern

PVC PWMG0105

Oppein Quartz Stone P5 Series PWTY1032

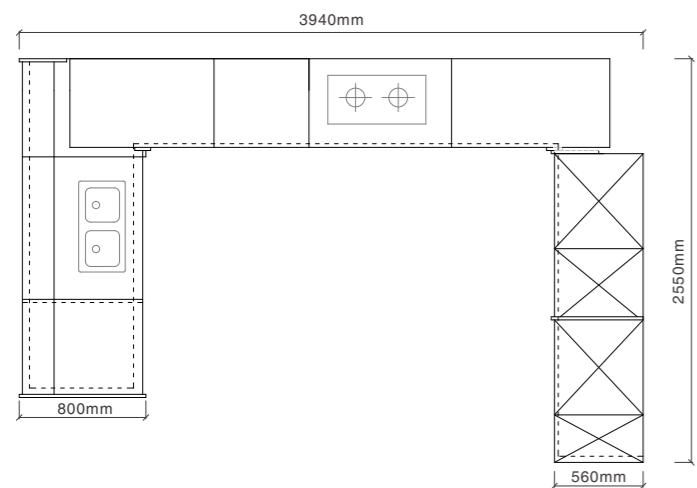

Light cocoa color PVC intersects with classic white oak grain, embellished with matte dark metal elements, coming together as a complete entirety, through which its industrial style is vividly displayed. The wall cabinet integrates a variety of storage elements to optimize both display and storage space utilization of the kitchen cabinet.



BEAR PLCC20076

Style: Minimalism

Melamine PWMA0164, BWMA0026
Oppein Quartz Stone P2 Series PWYT1007

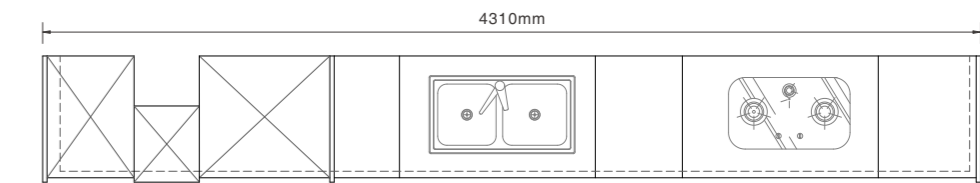

The combination of green and gray is a new visual element of the moment, which is visually pleasing and healing. Gray tone contains a sense of refinement, while moss green color seems as soothing as milk, creating a quiet and comfortable kitchen atmosphere, and offering a place of relaxation.

TIME SQUARE PLCC20094

Style: Minimalism

PVC PWMG0156, PWMG0156
Oppein Quartz Stone P3 Series PWTY1048

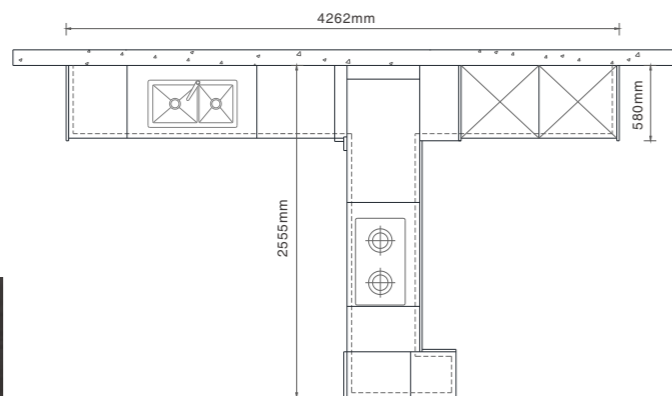

Green is the color that represents life, hope, and vitality. The dark gray void is dotted with patches of green, adding vitality and solemnity into the setting. Under this kind of decoration, it will never be out of fashion since it always creates a peaceful and vibrant atmosphere for home.



MOMA PLCC19119

Style: Minimalism

Melamine PWMA0114, PWMA0119
 Oppein Quartz Stone P5 Series PWTY1031

With the state-of-the-art 45° edge-cutting craftsmanship, this handleless kitchen reflects a minimalist lifestyle. The high ribbed glass fronts bring not only a touch to the space, but also showcase the contents elegantly. On the right, the electrical appliances are hidden behind the walnut fronts concisely. Equipped with Australia-made Eclipse sliding door system and when pulled out, the walnut sliding doors can be concealed and discreetly integrated into the wall.

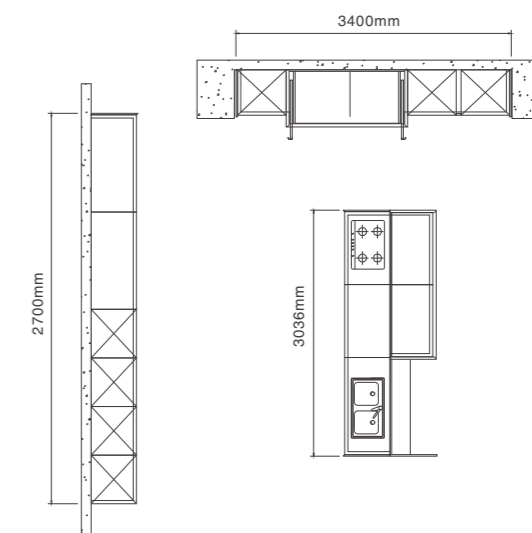

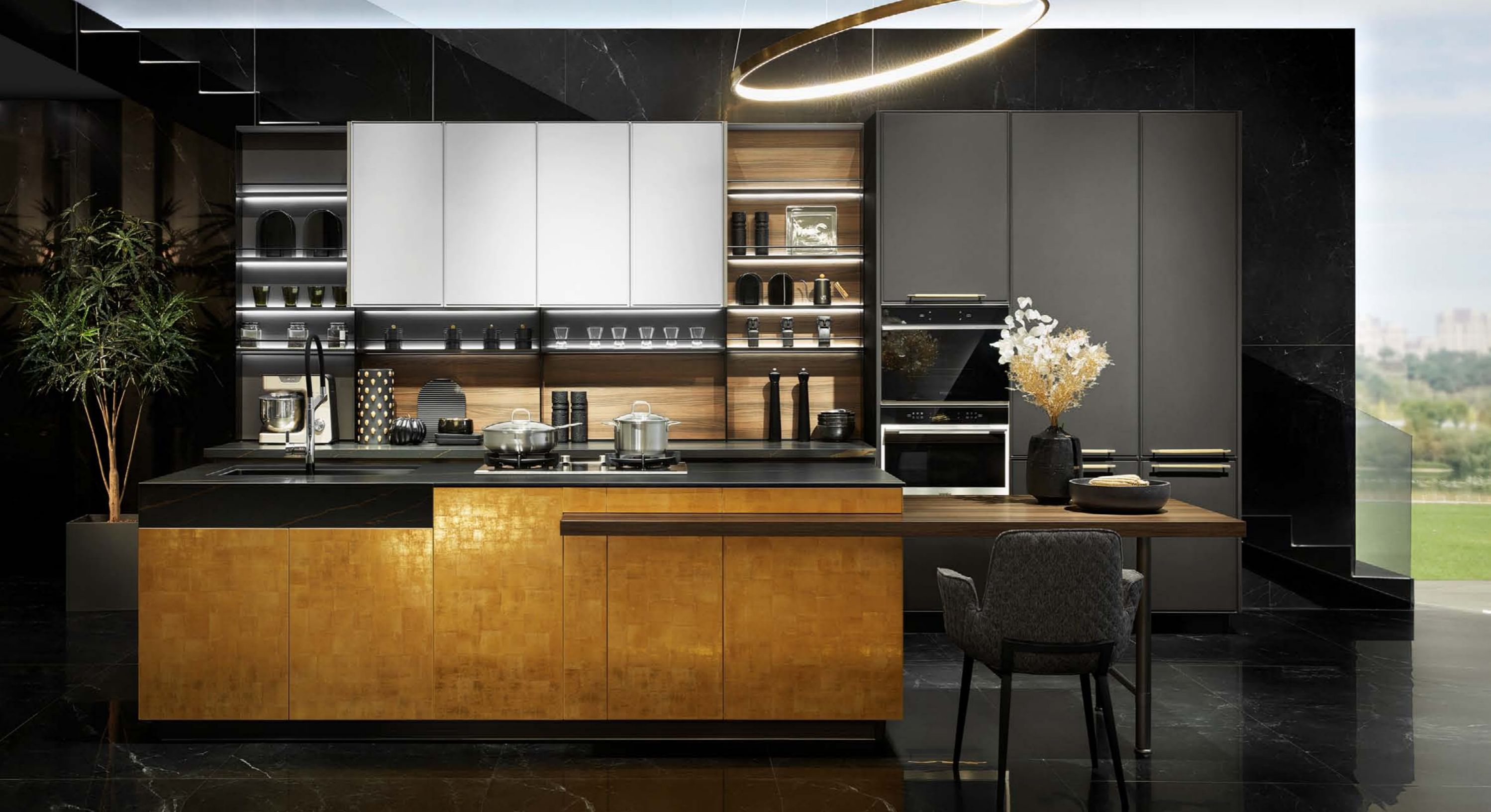

GOLD COAST PLCC20030

Style: Industrial

Lacquer PWMK7001, PWMK7004+Flat Laminate PWMP2007
+Melamine PWMA0122
OPPEIN Sintered Surface PWTE0007

Mixing wood tones and golden color have endowed this kitchen with casual elegance, like the extended dining table and back panel for the open cabinet. Combining with ergonomic principles, we have developed a powerful storage system, which is to use multi-shelves to improve the utilization rate by more than 17%.

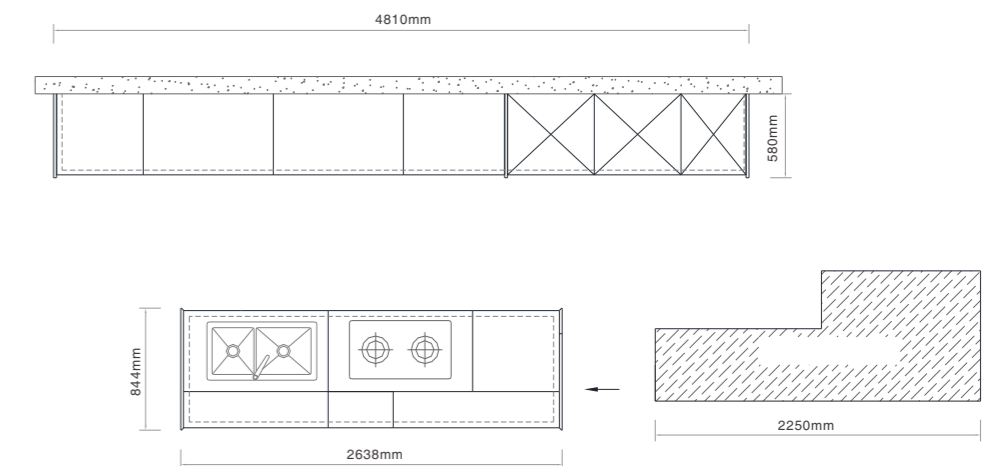

ODE TO JOY PLCC18082

Style: Industrial

HPL PWMF0047, PWMF0017

4110mm

Oppein Quartz Stone P2 Series PWTY1008

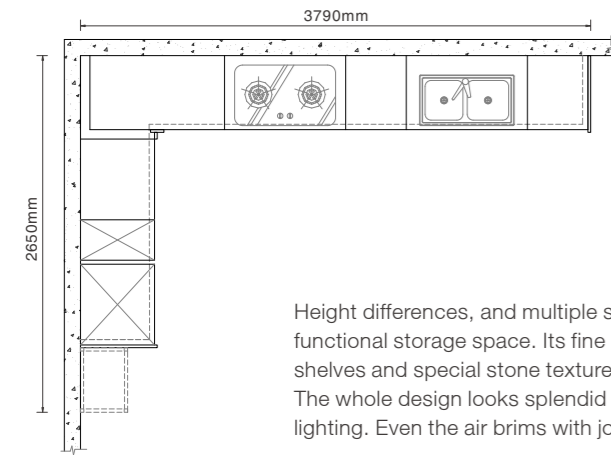

Height differences, and multiple space levels, enable clear divisions of functional storage space. Its fine details including glass doors, metal shelves and special stone texture elements, reveal its striking industrial style. The whole design looks splendid in white, and dazzlingly beautiful with the lighting. Even the air brims with joy and ecstasy.





REMINGTON PLCC19019

Style: Industrial

Melamine PWMA0117

Oppein Quartz Stone P5 Series PWTY1046

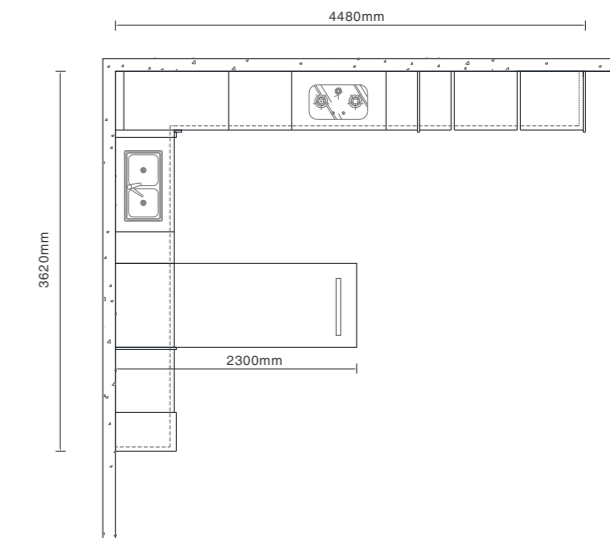

The rusty style door panels have an authentic rock appearance, plus with the black frames and glass fronts, give a distinct industrial feel. The kitchen is perfectly harmonious with the rough interior such as concrete floors and ceilings.

MAGIC-Q III PLCC20108

Style: Industrial

UV Lacquer PVMC0003+Melamine PWMA0136

Oppein Quartz Stone P3 Series PWTY1048

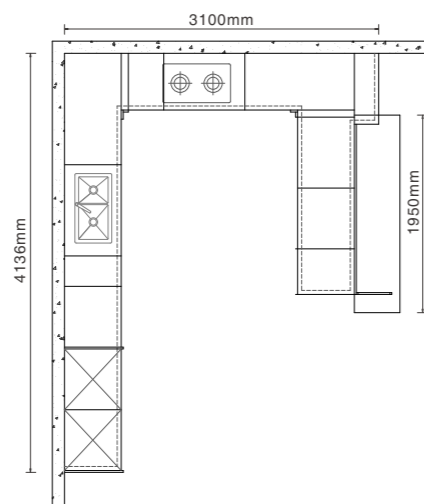

An intense industrial style pops out from the combination of black rock texture and smooth pearlescent white door panel. Simulated rock panels in graceful white color have imparted an air of calmness and elegance. Magic-Q III with its cutting-edge technology just redefine intelligent kitchen for a new era. Using its functional accessories and smart appliances is like opening surprise boxes. It's a kitchen full of magic. You never know what they could lead to.





HOUSTON PLCC19008

Style: Industrial

Flat Laminate PWMP2005+Metal Foil PWMJ0006
Oppein Quartz Stone P5 Series PWTY1046

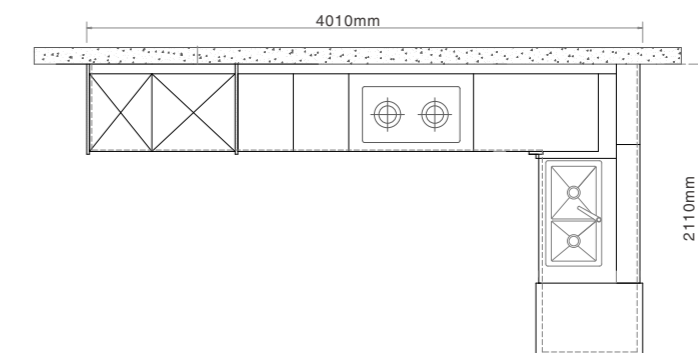

Out of pragmatic concern for high efficiency, this kitchen is designed to adapt to the fast-paced urban life. L-shape layout, presents a clean and tidy look. Functional bar design would allow you to unlock its storage secrets inside. With metal texture, simple lines, proportion and function design, and even the color scheme of metal gray and dark gold, all these elements depict an industrial style, for the sake of convenience and efficiency, so that urbanites can still enjoy the process of cooking at the end of their busy days.

TANGULA PLCC20032

Style: Industrial

Lacquer PWMK7005+Melamine PWMA0122
Opplein Sintered Surface PWTE0008

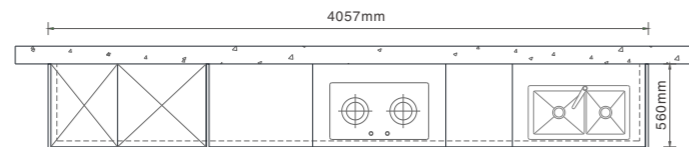

The clean door panel and concealed handle become an integrated design. The design of the unique curved door panel makes the kitchens more beautiful. Simple dark green door panels merged with wood grain back panels, present the Scandi-industrial style perfectly. Brand new lacquer material is not only environmentally-friendly but also practical. And compared to the common lacquer, it's more cost-effective.



ERHAI PLCC20017

Style: Entry luxury

Lacquer PWMK2090, PWMK2002+Melamine PWMA0136
Oppein Quartz Stone P5 Series PWTY1033

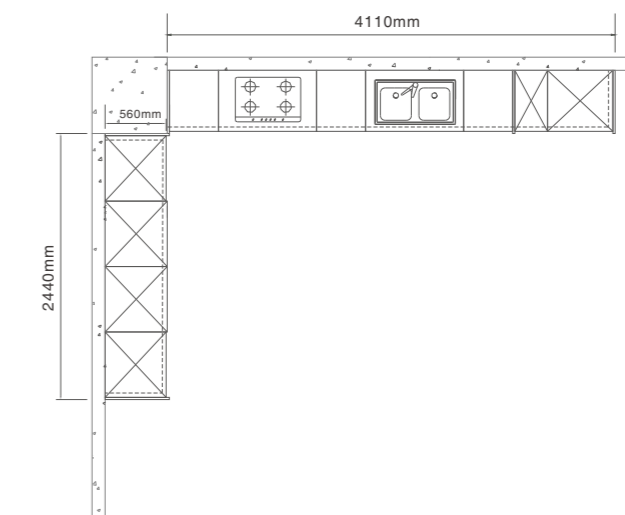

The design of this kitchen cabinet, is inspired by the fabulous scenery with clear blue sky and white clouds. Decorating a bit of gold on the door panel brings a sense of low-key luxury. With such a simple and minimalist design, the metal shelves become the highlight of this kitchen.

MULSANNE PLCC19001

Style: Entry Luxury

UV Lacquer PPMC0015+Melamine PWMA0115
Oppein Quartz Stone P5 Series PWTY1044

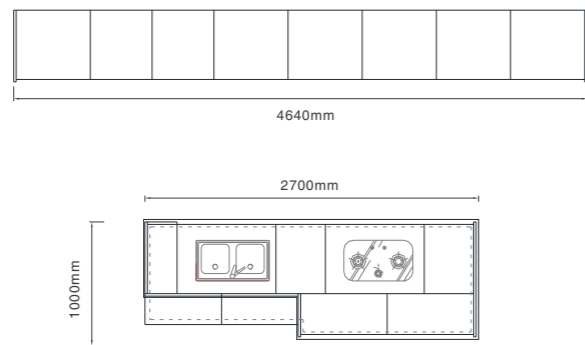

The high gloss rust-grey door panels come with clear glass fronts and present an elegant look. Red oak open shelves have fine texture and offer spacious storage with easy accessibility.



ELYSEES PLCC20016

Style: Entry Luxury

Lacquer PWMK1053+UV Lacquer PWMC0032
Spain Sintered Surface PWTE0005

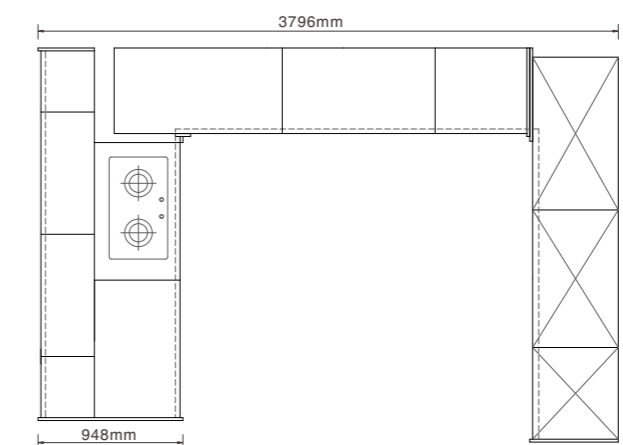

A muted palette of gray lacquer matches the skin-like wood grain texture, and seems harmonious with ultra-narrow aluminum frame in champagne color. A clear and graceful silhouette begins manifesting itself with those simple lines. Stepping into this bright and refreshing kitchen, you may feel as if you were wandering on Avenue des Champs-Élysées, known as world's most beautiful avenue.





STARRY PLCC19099

Style: Entry Luxury

UV Lacquer PWMC0016+Melamine PWMA0114
Oppein Quartz Stone P5 Series PWTY1007

The design is pleasingly simple, followed by its natural stone texture. Wood grain mingle with plain white, adding a touch of class and charm to your home. The space seems boundless stretching away with few draws of straight line and flat face as if you were in the middle of the vast galaxy.

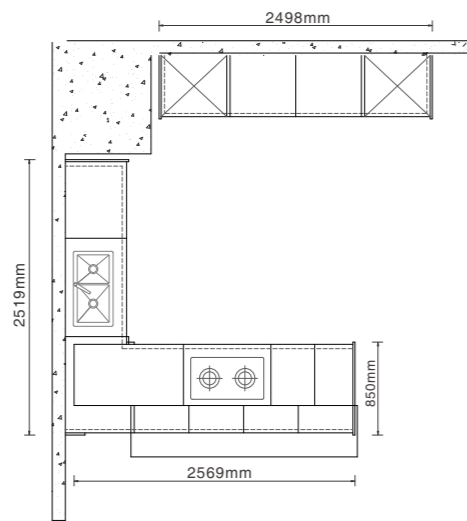



MODERN TIMES PLCC18067

Style: Entry Luxury

UV Lacquer PWMK3007, PWMK0011+Lacquer PWMK2008
Oppein Quartz Stone P5 Series PWTY1031

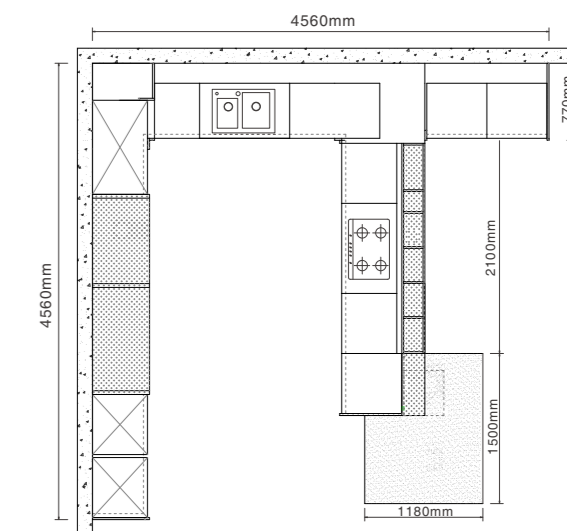

It is a new type of kitchen design idea to achieve both its storage function and recreational function, by dividing different functional storage areas and setting up spatial hierarchy. Countertops, cabinets and walls could all stay put up and tidy, with better storage optimization solutions. Such a social kitchen is an apt fit for modern urbanites.



ELLIS PLCC20093

Style: Nordic

Melamine PWMA0131

Oppein Quartz Stone P1 Series PWTY1018

With various space levels and its simple layout set up, stylish wood grain texture and pure white door panels make up a harmonious scene, which conveys a sense of elegance and comfort. Chests of wood grain drawers reinforces its Nordic style. Its wall-mounted system also serves a practical purpose in terms of optimizing the space utilization and enriching its functionalities.

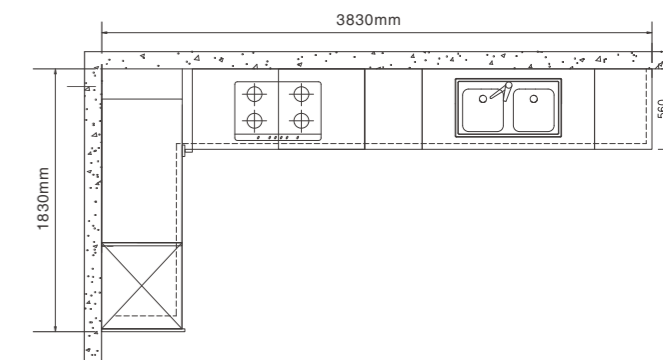

FENDI PLCC20105

Style: Nordic

Melamine PWMA0167
Oppein Quartz Stone P5 Series PWTY1033

Light-colored cloth-like texture and light-colored wood grain is the classic collocation for kitchens. Warm tones make the whole setting look cozy and comfortable. Another bright spot of the kitchen is the black metal frame. Humble as it seems, it is actually a stroke of genius, carrying a sense of art with it.

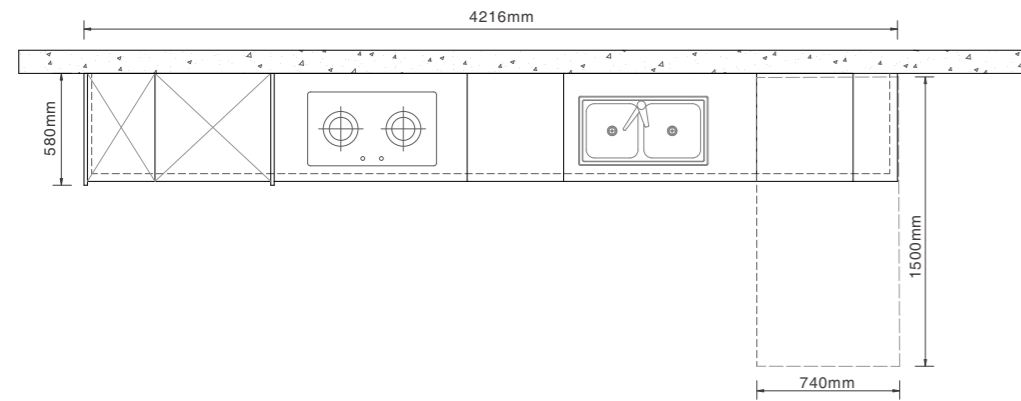

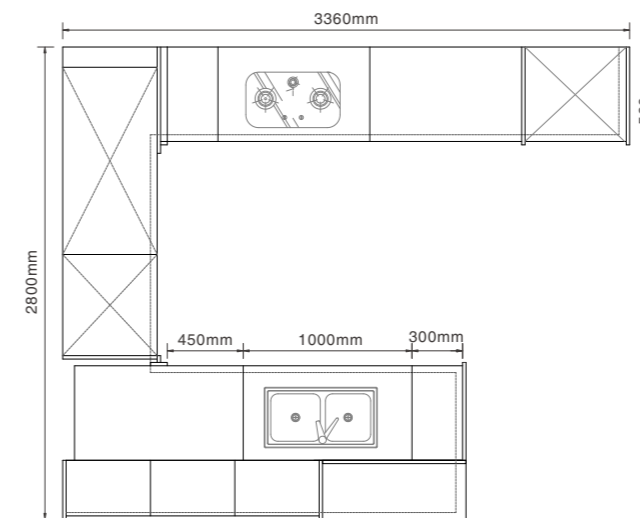

CHRISTIN PLCC19062

Style: Nordic

Melamine PWMA0113

Oppein Quartz Stone P5 Series PWTY1046

The primary color of the wood grain makes it look more natural and organic. By illustrating the essential traits of kitchen cabinets based on comparative aesthetics theory, it is aimed to create a life style that fits modern young people. Classic U-shaped layout, clear divisions of storage space and streamlined operation areas perfectly embody its five major functional systems.

LAKE BAIKAL PLCC18051

Style: European Minimalism

PVC PWMG0061, PWMG0102

Oppein Quartz Stone P5 Series PWTY1033

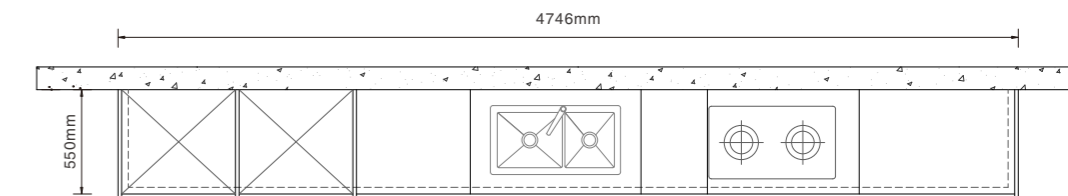

The way blue-gray door panel closely connects with the white ones, looks as if fleecy white clouds and blue lake were echoing each other. The grid door panel of sink cabinet appears refreshing and idyllic. Its simple and elegant appearance, in a perfect proportion, creates a scene of tranquility. The little stylish door decoration enlightens the whole design.

MANZANILLO PLCC20101

Style: European Minimalism

PVC PWMG0061

Oppein Quartz Stone P5 Series PWTY1031

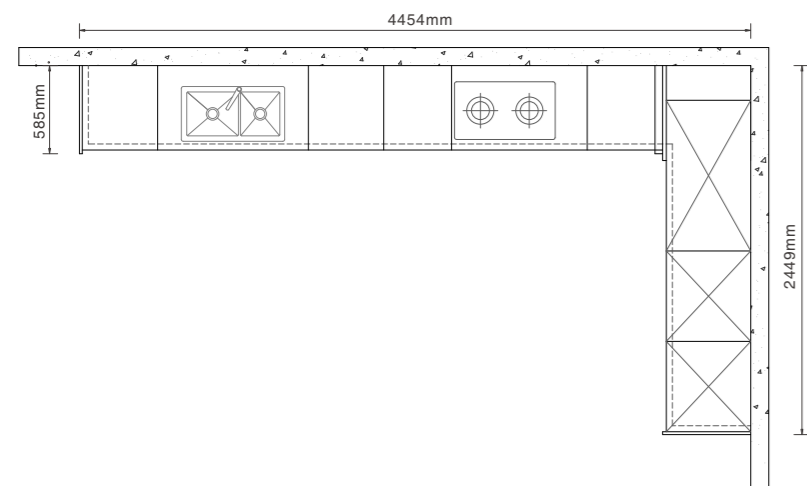

Simple and elegant lines of the doors make the cabinet look clean and graceful, the high-class white material gives it more aesthetic intension, and the striped glass makes it clear and clean. Light white PVC foil matches the brushed brass elements nicely. Exquisite and high-class PVC material with its matt and soft texture could fit a variety of decorative styles.





TALES OF AMERICA PLCC19021

Style: American

PVC PWMG0130+Melamine PWMA0113
Oppen Quartz Stone P5 Series PWTY1044

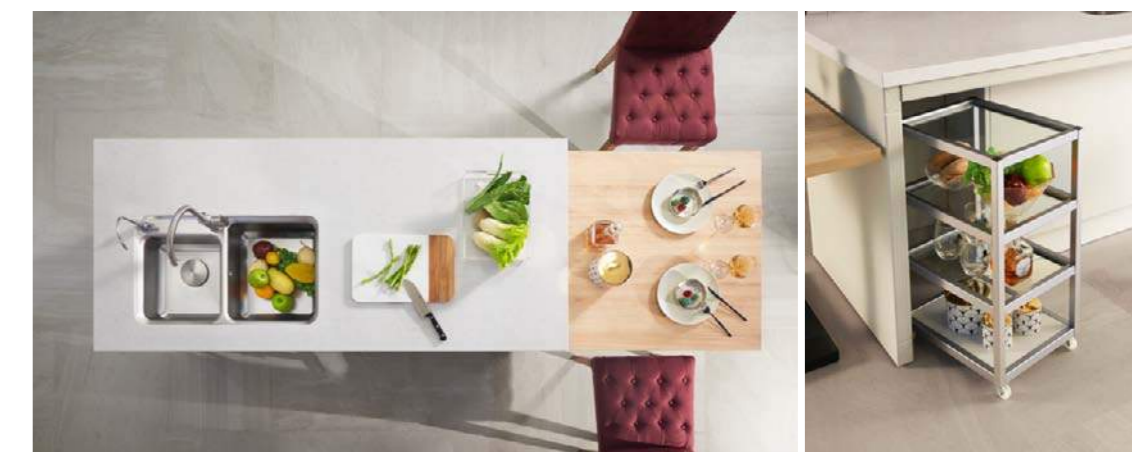
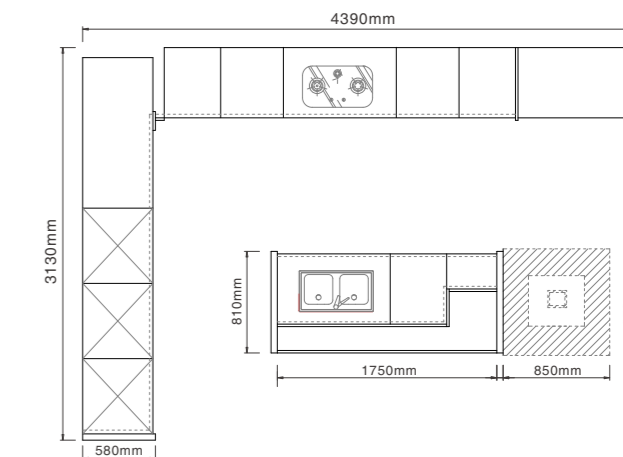

Modern PVC door panel with narrow frame, goes with the exceptionally soft stone texture, brings out its engaging appearance, and highlights its typical American minimalist style in a concise, tidy and neat manner. With white panel reflecting the light, the kitchen looks much brighter and more spacious, creating an ambiance of elegance and warmth. Happiness would linger in every corner of the kitchen when family reunions and parties are held.

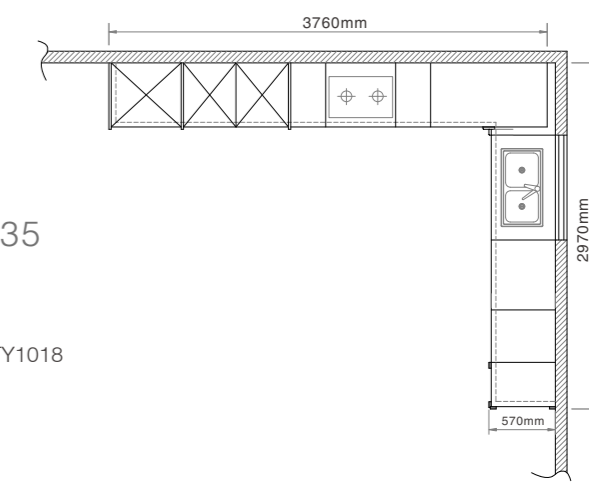

NICAEA OP14-035

Style: Classic
PP Foil PWMD0005
Oppein Quartz Stone P1 Series PWTY1018



People who live in the teeming city now tend to seek a simpler and happier life, clinging to "Back to nature, back to origin" living philosophy. Nicaea is the type of kitchen that every family desires. The antique and delicate solid wood leads you closer to nature, bringing you back to the old times, and casting an air of gentility and elegance to your house.

PREMIUM

CARCASE PANEL | 15mm thick plywood, four edges sealed with 1mm thick PVC.

BACK PANEL | 3mm thick MDF, both faces coated with melamine.

WOODEN SHELF | 15mm thick plywood coated with HPL, front edge sealed with 1mm thick REHAU PVC.

GLASS SHELF | front edge sealed with aluminum, stylish.

DRAWER PANEL | same as carcass panel, edges sealed with 0.6mm thick REHAU PVC

GLASS SHELF | front edge sealed with aluminum, stylish.

KICKBOARD | material can be aluminum, plastic, HPL, PVC or wood veneer. And colors can be black, silver or white, or customized to be coordinated with doors.



STANDARD | ECONOMICAL

CARCASE PANEL | 16mm thick particle board, four edges sealed with 1mm thick PVC.

BACK PANEL | 3mm thick MDF, both faces coated with melamine.

WOODEN SHELF | 16mm thick particle board coated with melamine, front edge sealed with 1.5mm thick REHAU PVC.

GLASS SHELF | front edge sealed with aluminum.

DRAWER PANEL | same as carcass panel, edges sealed with 0.6mm thick REHAU PVC.

KICKBOARD | material can be aluminum, plastic, HPL, PVC or wood veneer. And colors can be black, silver or white, or customized to be coordinated with doors.

CARCASE PANEL



7-layer Plywood

- ◆ 7 layers solid wood sheets, disperse the stress 40% loading capacity higher than other carcass material.
- ◆ Strong screw holding capacity to keep structure stable and long lasting service.
- ◆ 0.6mm thick laminate on both faces, heat and moisture resistant.
- ◆ Formaldehyde emission $\leq 1.5\text{mg/L}$, eco-friendly and complying with European class E1 standard.

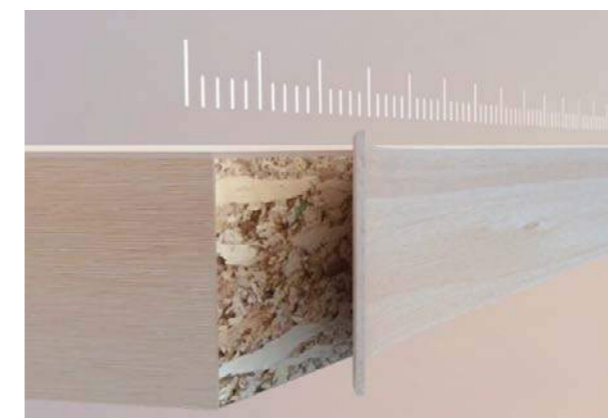

PVC Edging

- ◆ Front edge is sealed with 1.2mm thick PVC by HOMAG edge bander with extreme accuracy and precision while other side edges are sealed with 0.5mm thick PVC.
- ◆ JOWAT eco-friendly seal adhesive to guarantee tight seal and eco-friendliness.



Particle Board

- ◆ Wood chips cold pressed by 300 tons/m² with superior screw holding capacity and load bearing capacity.
- ◆ Keeping stable structure and long lasting service.
- ◆ Easy to clean and protect the carcass from chemical injury.
- ◆ Formaldehyde emission $\leq 1.5\text{mg/L}$, eco-friendly and complying with European class E1 standard.

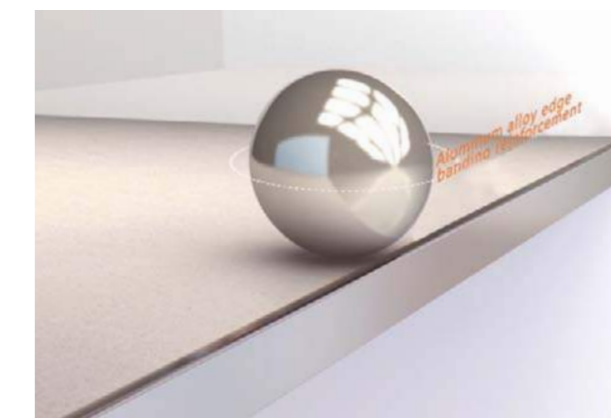

Glass Shelf Edging

- ◆ Glass shelf edge sealed with oxidated aluminum.
- ◆ Vogue and can keep round objects from slipping off.

CARCASE HARDWARE



Top Panel Connector

- ◆ To joint 45° cut crown molding, made from stainless steel.
- ◆ Rustless and extremely durable, allowing tight joints.

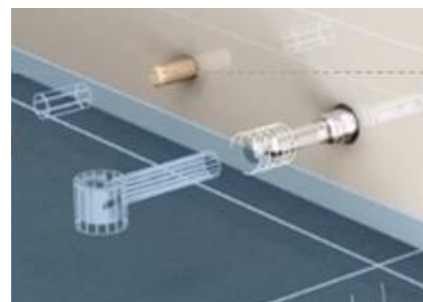

TITUS Quickfit Dowel and Sleeve Set

- ◆ 2 in one, high resistance to torsion and dowel pull out.
- ◆ Never loosen through time and ensure rigid construction.

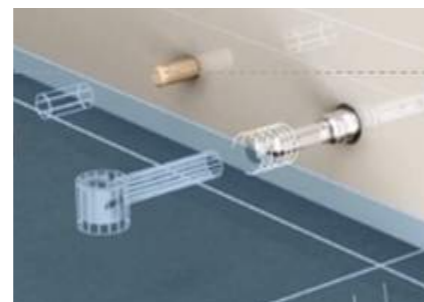

Hardwood Dowel

- ◆ Sturdy and long lasting, Ø8*30mm



Adjustable Leg

- ◆ Made from PP, each leg to bear 100KG weights, more than 20 years of service life.
- ◆ Leg length can be 80mm, 110mm, 130mm and 160mm.

CARCASE HARDWARE



Suspension Bracket Invisible

- ◆ HETTICH suspension bracket, 110KG loading capacity/set, durable and safe



Suspension Bracket Visible

- ◆ Made from nickle plated steel/ABS and withstanding 24hrs of salt test.
- ◆ Patented locking design to keep cabinets from slipping off.
- ◆ 65KG/pc powerful loading capacity.



Aluminum Crossbar

Instead of wooden crossbar, OPPEIN base units are mounted with aluminum crossbar, which can greatly reinforce the cabinet structure, support and protect your countertop.



Idle Hole Insert

- ◆ Made from food-grade plastic. Various colors optional to be harmonious with carcass interiors.
- ◆ To avoid moisture entry into holes.



Kpush-Tech Door Rebounder

- ◆ From ITALIANA FERRAMENTA, withstanding 80,000 fatigue tests.
- ◆ Perfect new silent automatic opening system for doors without handles or knobs.



Hettich/blum Hinges

- ◆ Made from stainless steel, nickle finished, or zinc alloy.
- ◆ Withstanding 200,000 cycle tests, to allow silent motion due to the mute dampener.



Cobra Glass Shelf Pin

- ◆ From ITALIANA FERRAMENTA, zinc alloy material, nickle finished, enhances the look of your cabinets.
- ◆ Nylon screw to allow to lock the glass shelf safely in place.



Waterproof Kickboard and Clips

- ◆ Kickboard made from aluminum, plastic or wood.
- ◆ Colors can be white, grey, black, silver, or wood grain colors to match your cabinets.
- ◆ High quality plastic fasten kickboards with adjustable legs tightly.



Rubber Buffer

- ◆ Mounted on door fronts to offset impact when door closing.
- ◆ To protect door fronts and avoid noise.



Wall Mounting Fitting

- ◆ German FISHER screw and anchor.
- ◆ Withstanding 24 hours of salt test, rustless and corrosion resistant.
- ◆ To keep wall units firm fastened, loading capacity of each anchor ≥800N.

CARCASE HARDWARE

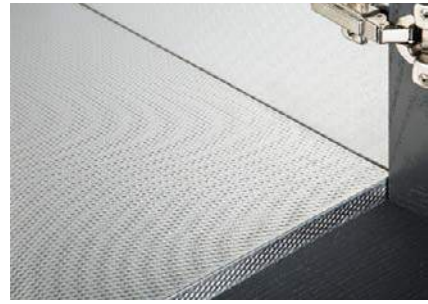

Aluminum Foil Of Sink Cabinet

- ◆ Bottom panel of sink cabinet is coated with aluminum foil, and edges are sealed with waterproof strip inserts, which keep cabinet from absorbing water.
- ◆ Aluminum foil has stylish looks and easy to clean.

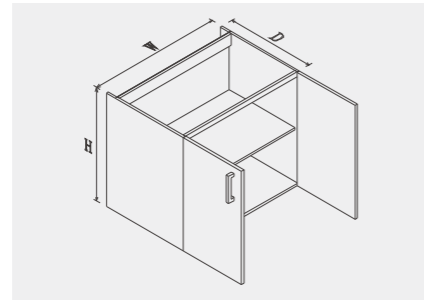

22mm Gap Between Backpanel And Wall

3mm thick MDF back panel is inserted into the groove of side panels, a 22mm thick gap are left between protruding side panels and back panels allows air ventilation, and thus back panels will not absorb moisture from wall, will not swell and ensure long service life.

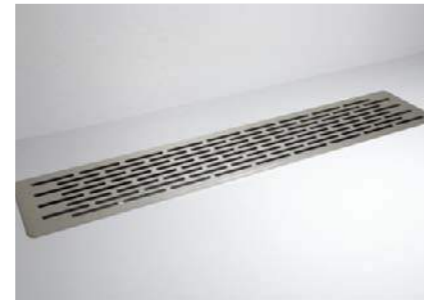

Ventilation Grill

Stainless steel, installed in stove cabinet to keep cabinets ventilation.

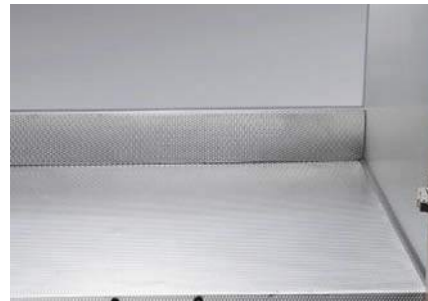

Waterproof Strip Insert

Waterproof strips are inserted in the edges of sink cabinet to keep particle board from absorbing moisture.



Undersink Aluminum Supports And Rails

- ◆ Under the sink, 10pcs of aluminum supports are arranged, which help support the weights and impacts evenly from sink and protect your countertops.
- ◆ Also, 3 pcs of aluminum rails are installed on the back side to offset the weights from worktop evenly.

DOOR FRONTS



Solid Wood

- ◆ Genuine broadleaf wood imported from North America, with rich, natural and clear wood grain, stunning linear texture
- ◆ 6 popular wood species optional including birch, cherrywood, alder, oak, ash and walnut.
- ◆ 8~12% moisture rate, not liable to distort or rupture
- ◆ Outstanding bending resistance; High scratch resistance and intensity.
- ◆ Good workability, sleekly section, good water resistance and adhesion performance.
- ◆ Lumber supplied by MATSON LUMBER COMPANY and GUTCHESS LUMBER, both are the world's best hardwood manufacturers in North America.
- ◆ Segment: premium



Lacquer

- ◆ 18/21/25mm thick MDF as core
- ◆ Eco-friendly lacquer are supplied by PPG and DAIHO, both are paint industry leaders in the world
- ◆ Superior yellowing resistance and weatherability to avoid discolor.
- ◆ Hardness is as high as 1.8, bringing outstanding scratch resistance.
- ◆ Matt or high gloss surface optional.
- ◆ Metallic lacquer optional, which is added silver powder to get metallic shiny surface.
- ◆ Segment: high and middle-end.



PVC Foil Coated

- ◆ 18/21/25mm thick MDF as core, seamless frame and core structure
- ◆ Front face coated with PVC, back face coated with white melamine
- ◆ PVC foils are supplied by RIKEN and RENOLIT, both are world-leading decor foil manufacturer High quality PVC foil, mainly supplied by Renolit and Riken
- ◆ Applying JOWAT eco-friendly glue
- ◆ Fine and beautiful wood grain
- ◆ Tough surface, superior scratch resistance
- ◆ Alternative for genuine wood



PP Foil Coated

- ◆ 21/25mm thick MDF as core
- ◆ Frame and core structure, both faces coated with PP foil
- ◆ PP foil has astonishingly excellent wood grain and texture, and it is the best alternative for genuine wood
- ◆ Classical looks same as genuine wood, but with outstanding price performance
- ◆ Segment: high and middle-end

DOOR FRONTS



Acrylic

- ◆ 18mm thick MDF/particle board as core
- ◆ Front face coated with inked acrylic, back face same as front face, or laminated with ABS décor paper
- ◆ Edges sealed with same-color acrylic
- ◆ Scratch resistant and easy care
- ◆ Excellent alternative for lacquer
- ◆ Segment: middle-end and economical



High Pressure Laminate

- ◆ 18mm thick particle board as core
- ◆ Edges sealed with 2mm thick REHAU PVC
- ◆ The decorative paper is 0.6–0.8mm thick, outstanding scratch and heat resistance
- ◆ Scratch resistant and easy care
- ◆ Segment: economical



Melamine

- ◆ 18mm thick particle board as core
- ◆ Edges sealed with 2mm thick REHAU PVC
- ◆ Both faces coated with high quality German SCHATTDECOR or SPAIN LAMIGRAF impregnated décor paper
- ◆ Natural colors or monocolors optional, fine texture
- ◆ Scratch resistant and easy care
- ◆ Segment: economical

COUNTERTOP



Caesarstone

- ◆ Imported from Israel.
- ◆ Eco-friendly and nonporous material.
- ◆ Scratch and wear resistant, antibacterial and easy to clean.
- ◆ Made of quartz, requiring minimal maintenance, no need to seal or wax, heat and aging resistance.



Counter Processing

- ◆ Countertop processed by imported Germany sophisticated machines.
- ◆ Slab precisely cut by advanced laser bridge cutting machine, tolerance within 0.5mm.
- ◆ High efficient water-jet CNC cutting machine used for cutting, hole boring and irregular profile moulding.
- ◆ Countertop profile moulded and polished by imported CNC center, insuring precise and high quality.

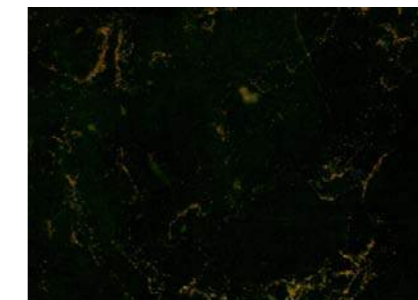

Silestone

- ◆ Imported from Spain. Made up of 94% natural quartz
- ◆ Hard and resilient, stain resistant, acid resistant, scratch resistant and heat resistant
- ◆ Impact resistant, bacteriostatic protection, can contact with food directly. Beautiful textures, high-end



Undermount Technics

- ◆ Dupont green glue used to fix sinks, 14 scientific progresses.
- ◆ No annoying glue residues, sleek and easy cleaning.
- ◆ Extra cross bars are in position to avoid possible countertop splitting or distortion.
- ◆ The bearing capacity is twice that of topmount.



Oppein Quartz Stone

- ◆ Outstanding scratch & impact resistance performance.
- ◆ Non-porous and highly stain-resistant to stains, such as wine, vinegar oil.
- ◆ Flame retardant, heat resistance (as high as 300°)
- ◆ Superior aging resistance; Nontoxic and no radiation.
- ◆ Minimal maintenance



Aluminum Cross Bars

- ◆ 3 horizontal aluminum bars are smartly designed to bear the weight from countertop equally, avoiding possible countertop splitting or distortion caused by uneven weight.
- ◆ Especially, at the back side of stove opening and sink opening, extra aluminum bars are in position to equally absorb countertop weight.

ERGONOMIC PLANNING

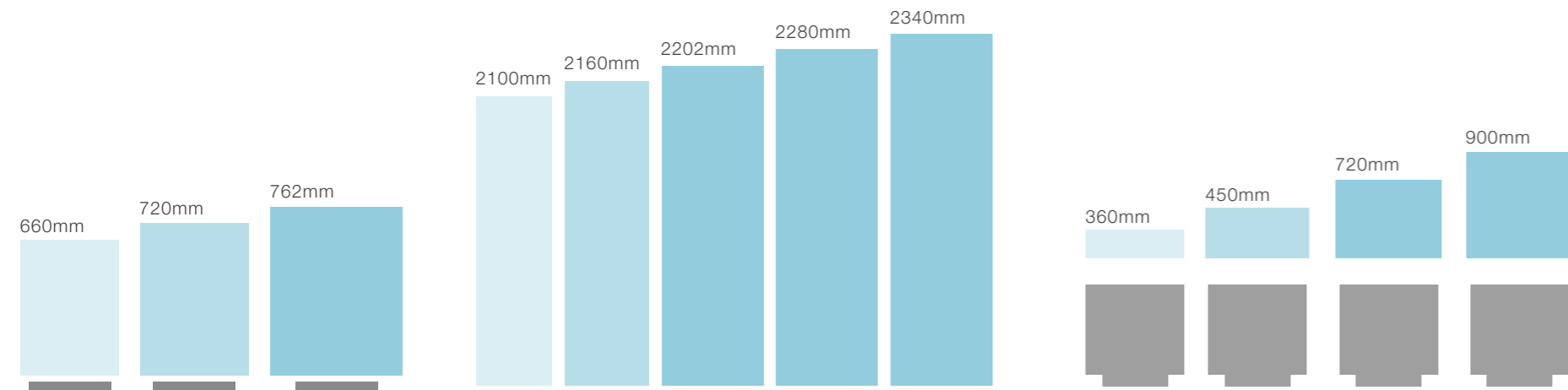

3 Heights Of Base Units

Multiple height choices, suitable for people with different heights.

5 Heights Of Pantry

Can be chosen freely, matching with multiple pull-outs, make reasonable use of high cabinet space. Ingenious design hides the appliance skillfully and keep the kitchen style unified.

4 Heights Of Wall Units

Accurate and user-friendly height, make good use of the upper space, matching with step ladder, easy to access. Optional concealed handle, can avoid knock against efficiently.

ERGONOMIC PLANNING

The basic rule of kitchen triangle is applied in each OPPEIN kitchen design. The primary task in a kitchen are carried out between the cook top, the sink and the refrigerator. These three points and the imaginary lines between them make up what kitchen experts call the work triangle. The idea is that when these three elements are in close (but not too close) proximity to one another, the kitchen will be easy and efficient to use, cutting down on wasted steps.

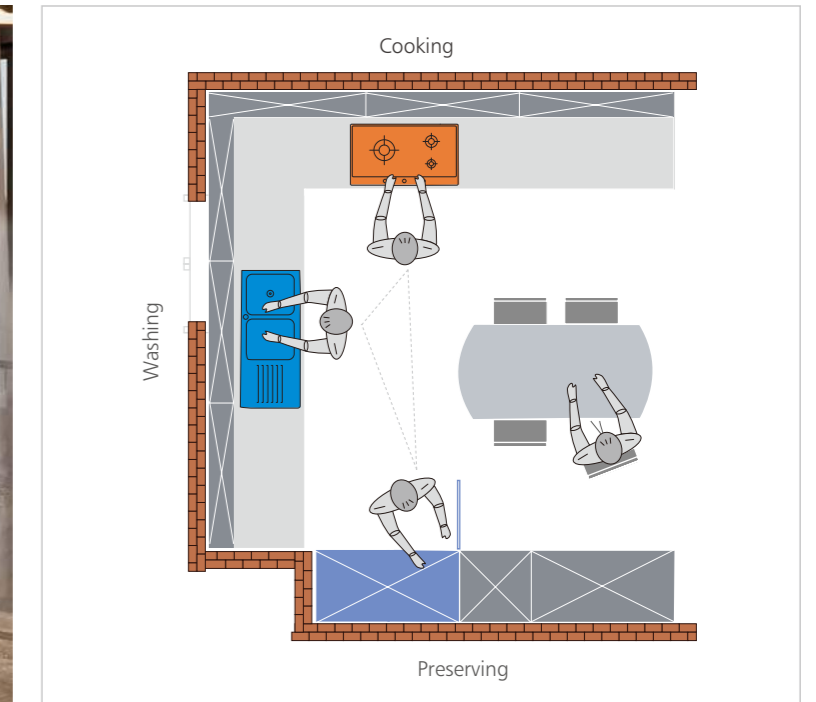

WALL FUNCTIONAL FITTINGS



Aventos HF With Servo-drive

AVENTOS HF works with two-part, bi-fold doors that fold in the center when opening. It is an ideal solution for tall wall cabinets with large doors because the handle stays within easy reach. With Servo-drive, doors can be opened with a simple touch, and a press of the switch ingrated into the carcass side panel, door closed again.



Aventos HS

AVENTOS HS lift systems open doors up and over the top of the cabinet, and they are ideal for wide cabinets with heavy, single doors.



Aventos HK-XS

AVENTOS HK-XS is a smaller, cost-effective lift system for shallow wall cabinets, like those above refrigerators and pantries. Its variable stop feature allows the door to stay in any desired position, so it's always within reach.



Aventos HK-S

With AVENTOS HK-S lift systems, you get the same operation of AVENTOS HK, but in a smaller package. These lift systems have been specifically designed to snugly fit in smaller cabinets, and they excel above refrigerators and pantries.



Aventos HL With Servo Drive

AVENTOS HL lift single doors parallel to the cabinet. It works great in kitchens with high ceilings, and crown molding will not be a problem because of the motion of the door. AVENTOS HL is also an ideal solution for a counter top appliance garage.

MAGIC STORAGE SYSTEM

Base Units

Everybody wants to have more storage in the kitchen. By reasonable layout, OPPEIN magic storage system can improve your storage space by 30%. Everything will find its place, no space is wasted.



MAGIC STORAGE SYSTEM

Pantry Units

No matter tandem or pull outs, our pantry pull outs always make best use of available space, and supports good organization and fast access. All the contents, even on the topmost shelf, are in clear view. Meanwhile, the built-in damping system can keep operation noiseless.



MAGIC STORAGE SYSTEM

Wall Units

Pull down the pull outs, you can easily access your storage in the wall or top of the high pantry. Still, the optimal layout makes full use of the space and makes storage tidy.



MAGIC STORAGE SYSTEM



Drawer Interior

The clever design of these drawer dividers means you can easily adjust them as you add and remove items from the drawers, keeping the contents upright, accessible and tidy.

Drawer dividers ensure you get the best possible use of the drawer space. No more clutters. The kitchen drawer dividers also simplifies preparation of your shopping list.



LIGHTING SYSTEM

Different types of down lights, strip lights and shelf lights, drawer lights and inductive lights offer not only additional illumination, but also create a happy mood in your kitchen. Our lights are harmonious with your kitchen space, and high quality LED strips or bulbs allow long service life and bring energy saving.



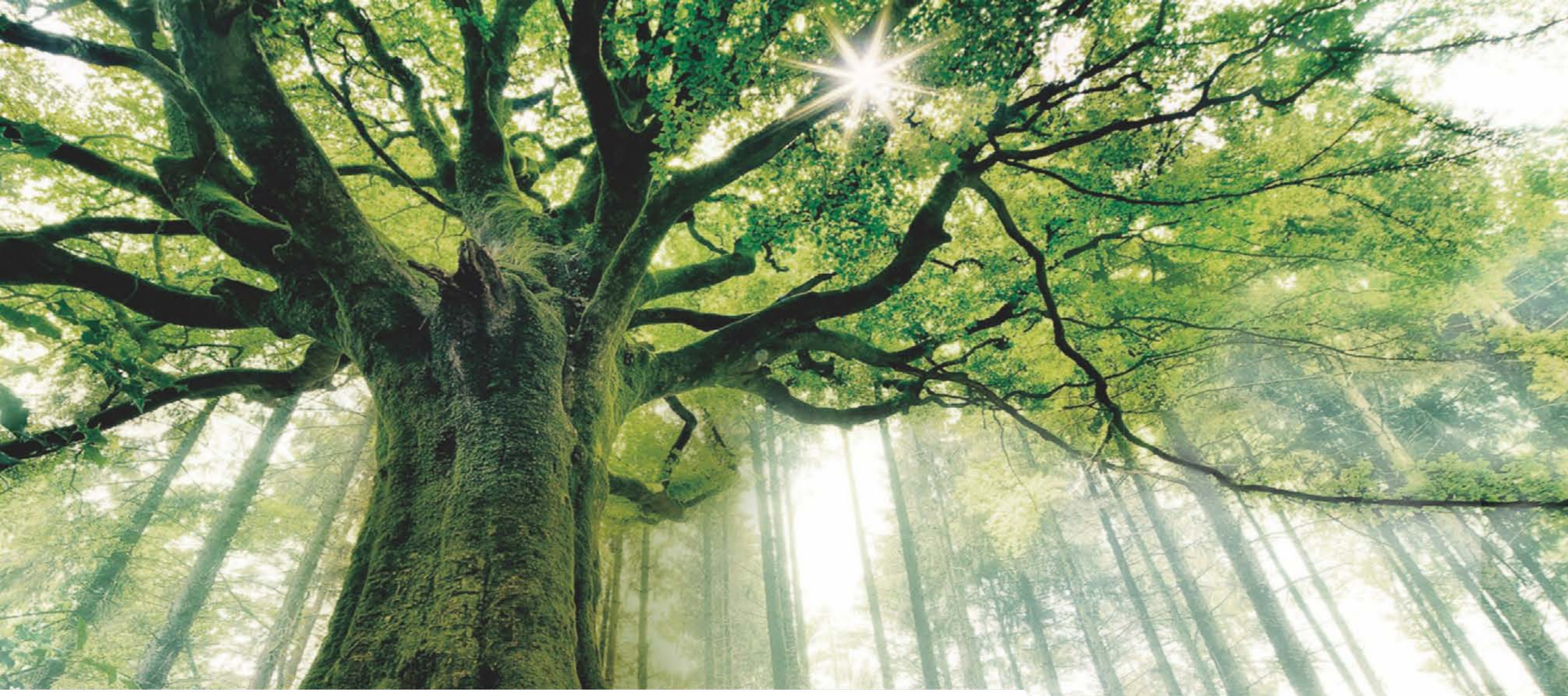

Quality Control

All our panels comply with emission class E1, pass tests with European chamber method EN717-1, and meet the stringent California Air Resources Board(CARB) emissions standards. Silestone, Caesarstone and other imported quartz stone are all Greenguard certified. And OPPEIN self-manufactured quartz stone is NSF certified.

CONTROL OF HAZARDOUS SUBSTANCES

Panels and Paints

Substances Test Standards Material	Formaldehyde Emission					Soluble Pb	Soluble Cd	Soluble Cr	Soluble Hg	Soluble Methanol
	China GB18584-2001	EU EN717-1:2004	USA ASTM D 6007:2014	Japan JIS A 1460-2015	Australia AS/NZS 4266.16:2004					
MDF	≤1.5mg/L	≤0.124mg/m³	≤0.13ppm	≤0.3mg/L	≤0.5mg/L	—	—	—	—	—
Particle board	≤1.5mg/L	≤0.124mg/m³	≤0.09ppm	≤0.3mg/L	≤0.5mg/L	—	—	—	—	—
Plywood	≤1.5mg/L	≤0.124mg/m³	≤0.05ppm	≤0.3mg/L	≤0.5mg/L	—	—	—	—	—
Test Conclusion	Compliant	Class E1 compliant	Compliant	F4 compliant	Class E0 compliant	≤90mg/kg	≤75mg/kg	≤60mg/kg	≤60mg/kg	≤500mg/kg

Countertops

Material Type	Item Value	Internal exposure index (IRa)	External exposure index (Ir)	Median lethal dose (LD50)
OPPEIN quartz stone		≤0.6	≤0.8	> 5000mg/kg
Solid surface		≤0.6	≤0.8	> 5000mg/kg
Imported quartz stone		≤0.6	≤0.8	> 5000mg/kg

Adhesives

Material Type	Item Value	Free formaldehyde	Benzene	Methylbenzene & dimethylbenzene	Halohydrocarbon	TVOC
Adhesives		≤100mg/kg	≤100mg/kg	≤500mg/kg	≤500mg/kg	≤50g/L

QUALITY CONTROL



FSC Certification

FSC is a forest certification, aims at promoting global responsible forest management. Our panels come from sustainably managed forests and controlled sources. Forest certification provides the guarantee that the wood products you purchase do not derive from questionable sources or over-exploitation, but rather originate from forests that are managed in harmony with nature.



CARB Certification

Formaldehyde is produced on a large scale worldwide. One major use includes the production of wood binding adhesives and resins. In 2009, the California Air Resources Board (CARB) released the toughest formaldehyde emission regulations for composite wood products. OPPEIN takes formaldehyde emissions very seriously and all panels we purchase CARB-certified.

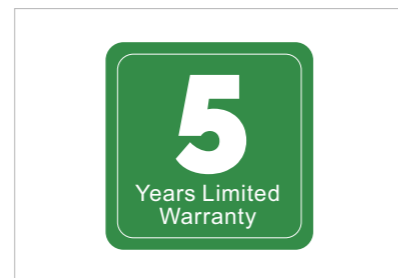

5 Years Limited Warranty

Cabinets manufactured by OPPEIN HOME GROUP are warranted to be free from defects in material and workmanship under normal use to the original consumer purchaser for a period of five years from the date of purchase.



NSF Certification

Our quartzstone is endorsed by the National Health and Safety Foundation (NSF) in accordance with international NSF 51 sanitary standards, and they are qualified for installation in hospitals, restaurants, hotels and more.

QUALITY CONTROL

We oversee every process that affects quality, such as:

- ◆ Supplier selection and assessment
- ◆ The quality of raw material, spare parts and finished products
- ◆ Product design and development
- ◆ Shipment and installation
- ◆ Documentation management

Every year, OPPEIN conducts more than 500 tests in its well-equipped test labs and the third party testing bodies.



Yellowing Tester



Salt Spray Tester



Constant Temperature and Humidity Chamber

KITCHEN CABINET PACKING PRE-ASSEMBLED PACK



STEP 1

Wrap each cabinet completely with EPE film, no exposures.



STEP 2

Fix EPE film with blue tapes.



STEP 3

Protect edges with cardboard edge protectors



STEP 4

Tightly wrap the cabinet with stretch film.



STEP 5

Label the cabinet with shipping mark.



STEP 6

Stack pre-assembled units orderly from one side to another side. Packed units must NOT exceed pallet boundary.



STEP 7

In order to keep the stacks stable, make sure the stack height is less than 2350mm (including the pallet height).



STEP 8

Cover the 4 side edges with cardboard edge strips, then fix it with tape.



STEP 9

Tightly wrap all units with stretch film.



STEP 10

Cover the top edges with cardboard edge strips, then fix them with tape.



STEP 11

Tighten the palletized units with plastic belts. 4 belts in horizontal direction and 2 belts in vertical direction.



STEP 12

Label the pallet with shipping mark. The shipping mark can be specified.

KITCHEN CABINET PACKING FLAT PACK



STEP 1

Wrap each panel with EPE foam, no exposures



STEP 2

Cover each panel with honeycomb paper



STEP 3

Cut carton based on panel dimensions



STEP 4

Protect each panel with edge protectors.

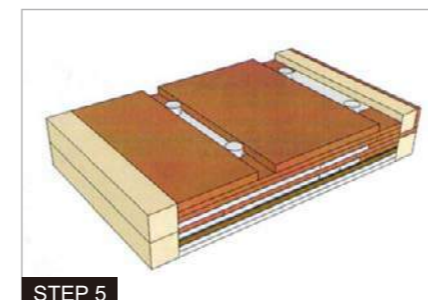

STEP 5

Stack packed panels into eight layers; and place the slide box at the left side and hardware box at the right side.



STEP 6

Cover the stack with carton and label it.



STEP 7

Tighten the carton with belts

COUNTERTOP PACKING



STEP 1

Check the countertop according to the drawing



STEP 2

Cut slats to size according to the countertop size. The longer pieces will be the sides of your crate and the shorter boards will be the ends.



STEP 3

Encompass the countertop with slats and attach them with a nail gun.



STEP 4

Stick the label on one slat



STEP 5

Cover the countertop with foam boards



STEP 6

Pack glue bottles and the backplash



STEP 7

Attach front rails to side slats with the nail gun.



STEP 8

Turn the countertop and box over, then fill the back voids with foam boards.



STEP 9

Attach back rails to side slats with the nail gun.



STEP 10

Enclose the sink with slats and attach the 4 slats with the nail gun.



STEP 11

Nail the metal corners onto side slats



STEP 12

Make sure the package is stable